



Easy Upgrades for Every Family



Inverter Heat Pump & Air Handler Product

Advance Residential Building Decarbonization

with ECO-AIR Inverter-Driven Heat Pump Systems

Variable-Speed Heat Pumps Are Surging into the Foreseeable Future

Heat Pump Shipments Top 4M in 2022

Outpacing gas furnaces for the first time

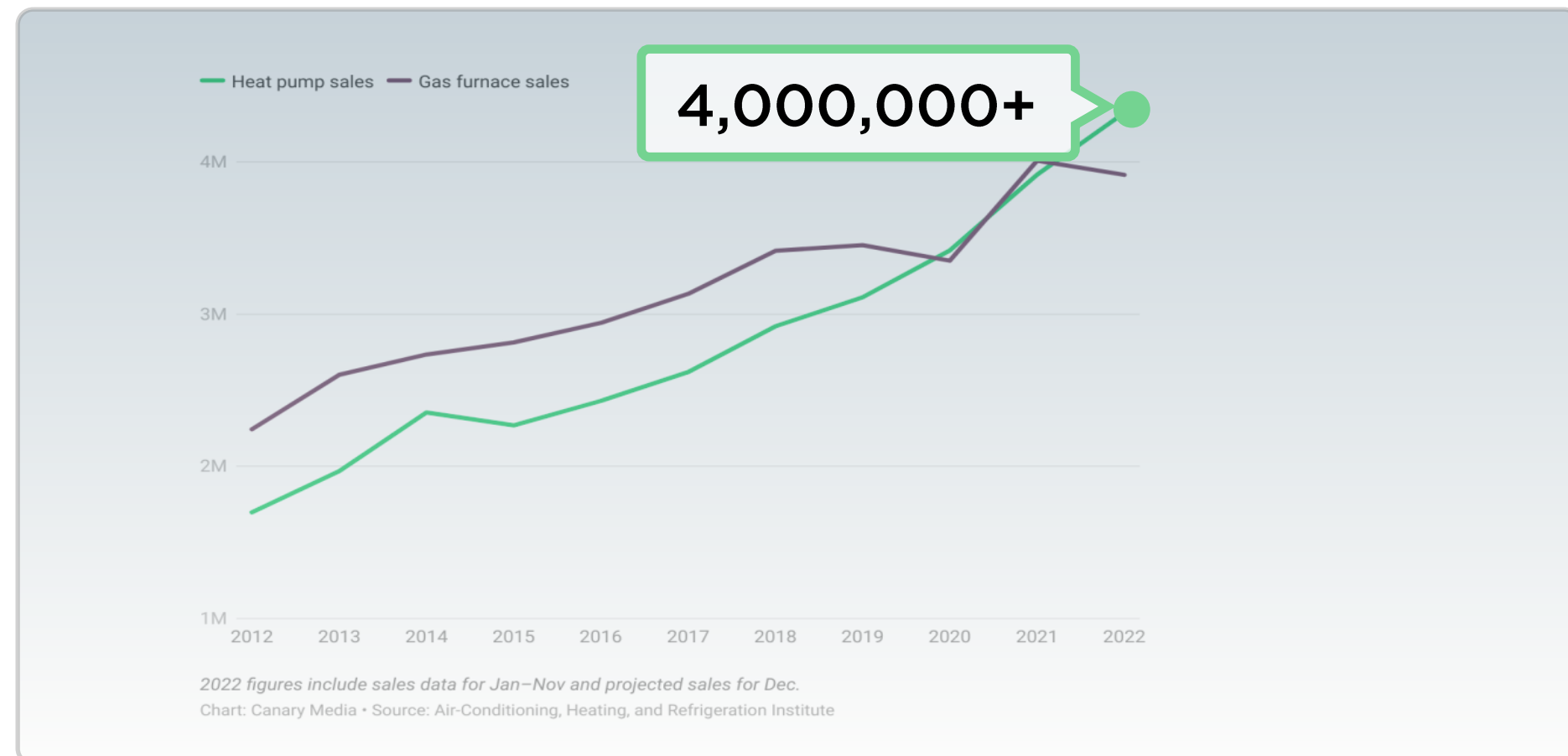

Rapid Growth of Ducted Inverter Products

19.97%

compound annual growth rate
2016-2021

AHRI Report 2022
BSRIA Report 101437/1B USA Splits
and VRF air conditioning

Joint efforts are driving the growth of VSHP

New minimum energy efficiency standards by DOE effective in 2023

1. 2023 Seasonal Energy Efficiency Ratio (SEER) Standards

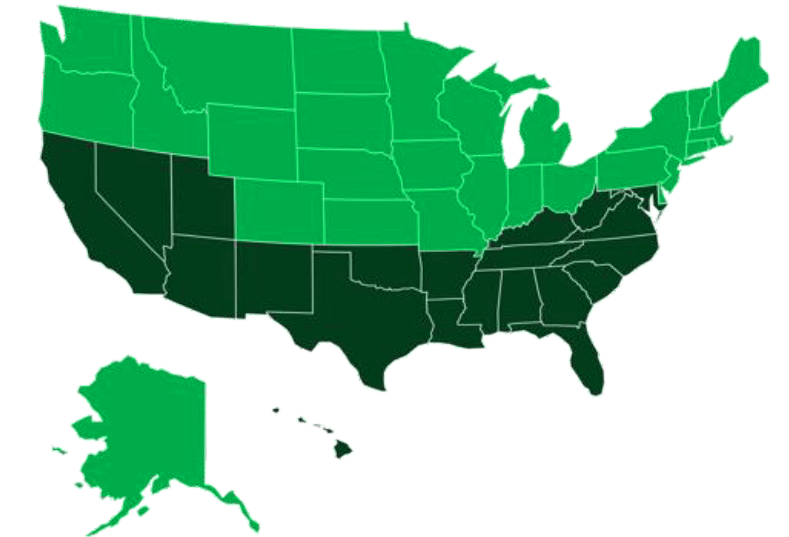

More government actions to accelerate the deployment of VSHP technology

2. The Department of Energy Cold Climate Heat Pump Technology Challenge

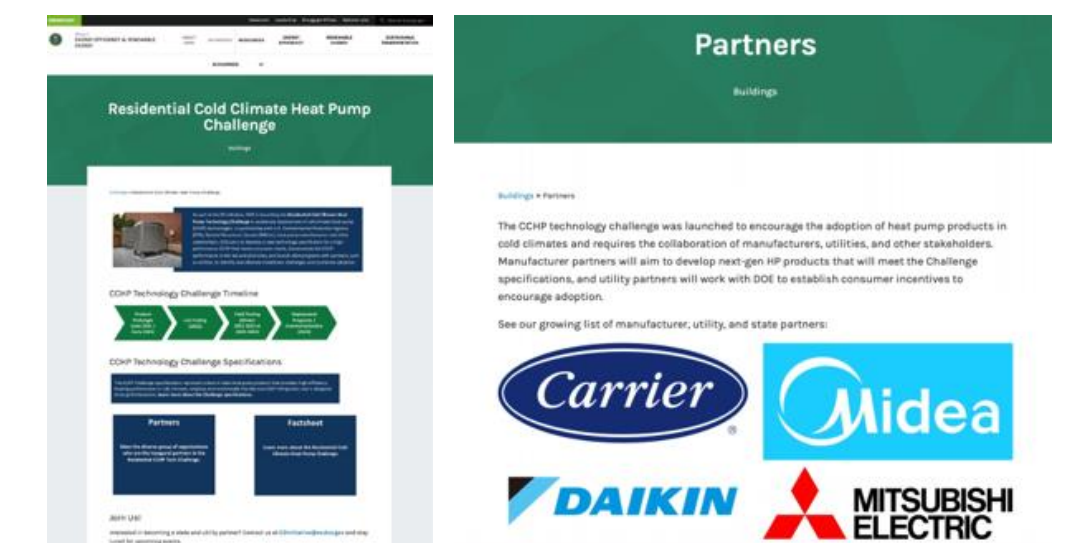

Expanded federal and local utility rebates to benefit more U.S. and Canadian families



Building Decarbonization Is a National Goal

At federal level



Goal

Net-Zero Emissions Buildings by **2045**, including a **50% reduction by 2032**

Investment
\$250 million

“The Federal Government will work across new building construction, major renovations, and existing real property to electrify systems, decrease energy use, reduce water consumption and cut waste.”

At state level

Building Decarbonization Roadmaps, put forth state by state

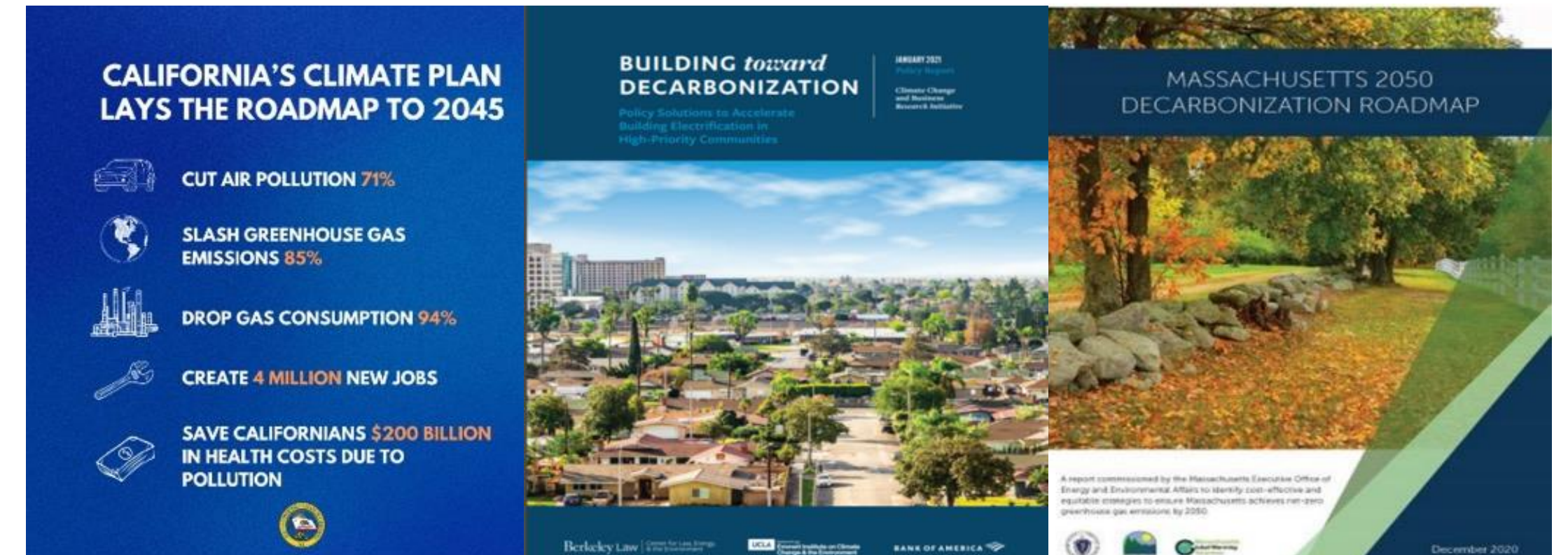

Deployment of Electric Heat Pumps a significant step to reach carbon neutrality

California

California's Climate Plan by 2030

3 million
climate-friendly homes

6 million
heat pumps deployed

New York

Clean Heat For All Challenge

To spur an innovative Packaged Window Heat Pump, enabling rapid, low-cost electrification of space heating in multifamily buildings

Huge Opportunity for Heating Innovation Upgrades

Space Upgrade Opportunities

Propane 5% Oil 4% Wood 2% Other 2%

47% Natural Gas

of homes in U.S. are heated with traditional natural gas.

40% Electricity

are using “expensive” electric resistance heaters or first-generation heat pumps, which underperform when temperatures dipped below freezing.”

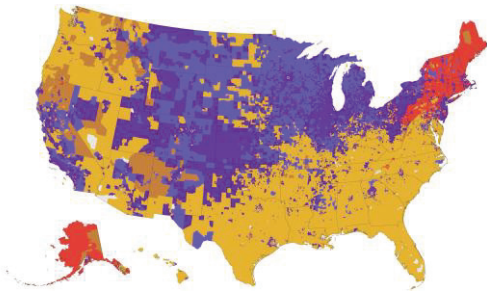

Source: The Washington Post

Space for Old Heating equipment Upgrade

Main air-conditioning equipment age	Total U.S. 108.9M	Apartments (5 or more unit building) 19.5M
Less than 2 years old	14.3%	10.4%
2 to 4 years old	20.0%	17.0%
5 to 9 years old	27.1%	26.1%
10 to 14 years old	18.8%	19.0%
15 to 19 years old	10.1%	13.2%
20 or more years old	9.7%	14.3%

Air conditioning in U.S. homes, by housing unit type

Nearly **40%** of U.S. residential AC systems are

Nearly **50%** of U.S. multi-family AC systems are

10
years old+

US EIA RECS Table HC7.1 Air conditioning in U.S. homes, by housing unit type, 2020

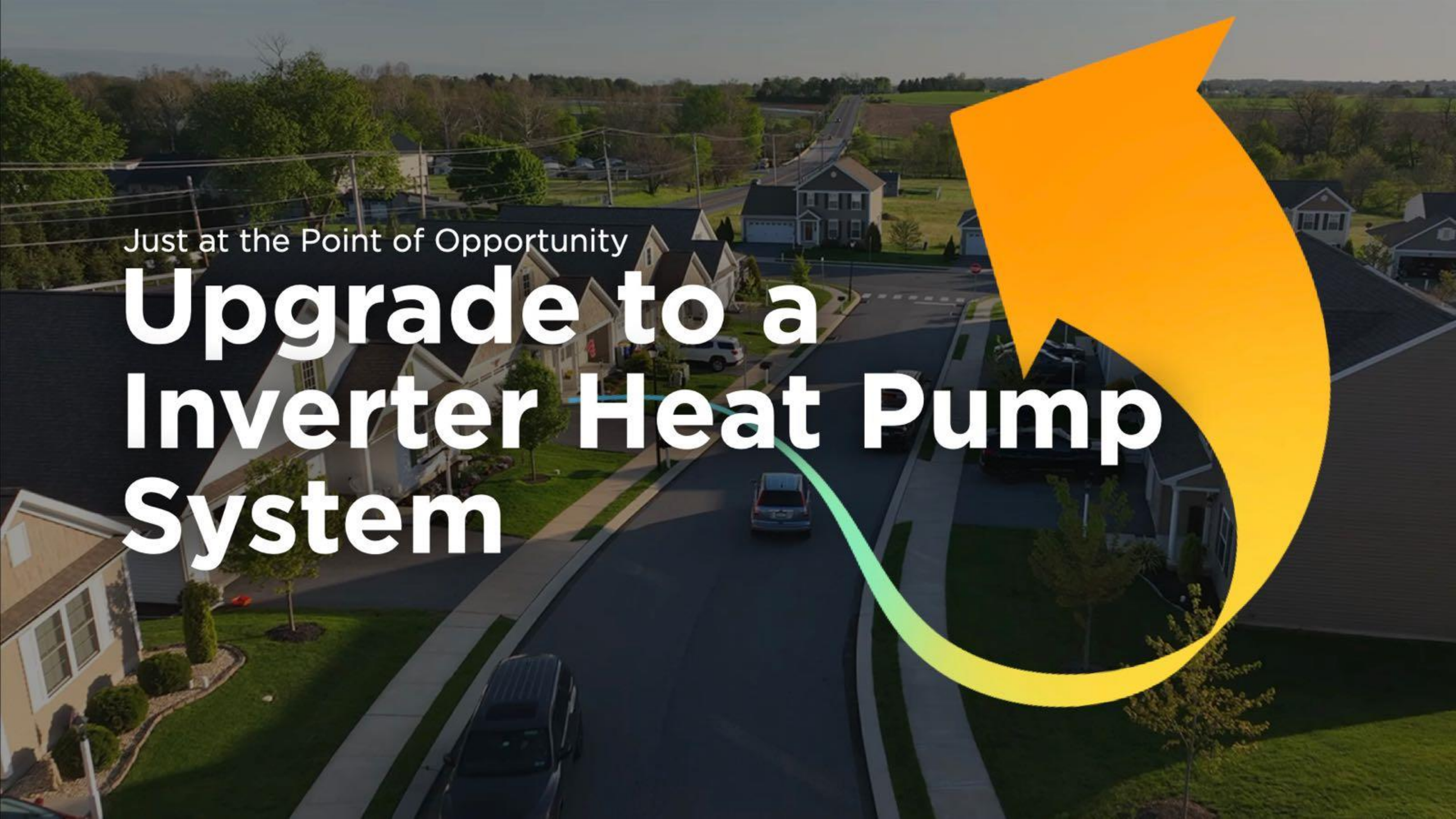

Just at the Point of Opportunity

Upgrade to a Inverter Heat Pump System

All About Cost Reduction

90% of apartments in U.S. are rental properties.
Lowering heating costs are a priority for builders and owners

Lower Purchasing Cost

Tax credits

More federal tax credits under IRA encourage homeowners, including renters for certain expenditures, to purchase heat pumps that meet the specific efficiency tiers established by the Consortium for Energy Efficiency (CEE)

30%

Of project cost

UP TO **\$2,000**
Per year



Source: The Department of Energy

Home Energy Rebate Program

IRA also includes \$8.8 billion to be made available through states and Tribes for consumer home energy rebate programs.

a **\$2,000** tax credit cap per household

Source: The Department of Energy

\$8,000

with an Rebate cap for heat pump Installation costs

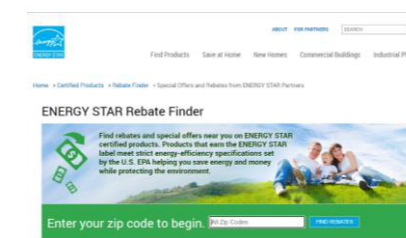

Source: Energy Star

Grant



Natural Resource Canada (NRCan) initiates The Greener Home Grant Program to help Canadians make where they live more energy efficient.

\$2,500 - \$2,500 CAD

For air source heat pump system installation

Source: Natural Resource Canada (NRCan)

Lower Running Cost

More energy savings

With up to **300%** efficiency a heat pump can be more energy efficient than a gas furnace (up to 97% efficiency)

Source: LEARN METRICS



More cost savings

Heat pump costs Less than \$600 for the entire winter

while electric heater costs over \$1600

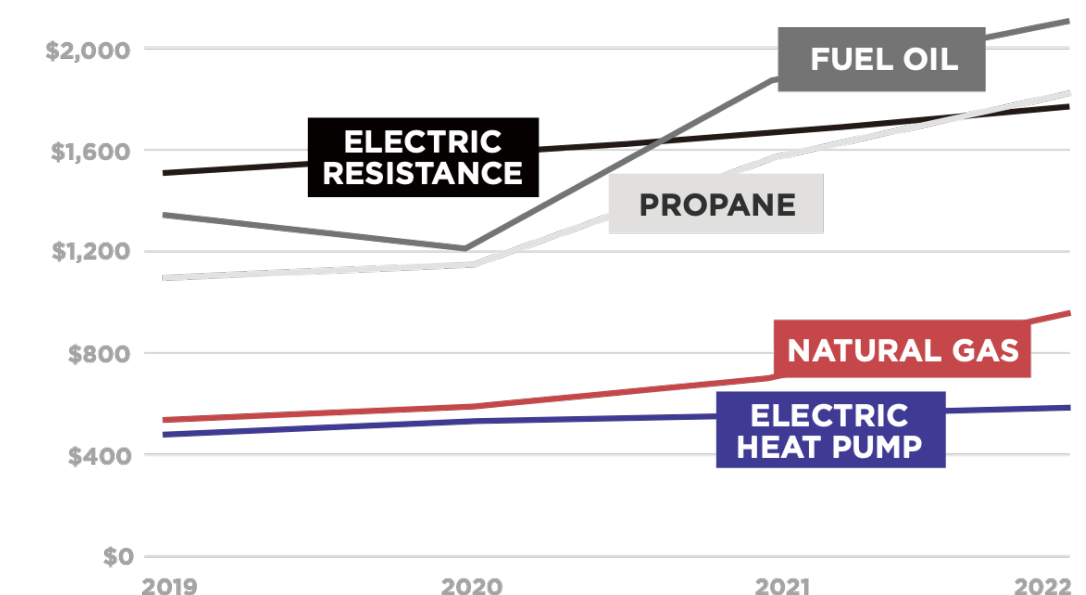

ECO-AIR

Easy Inverter Heat Pump Upgrades
Like Never Before



ECO-AIR Easy Upgrade Solutions

Innovative High-Efficient Electric Heating Options



Standard

Single Family Houses



Wall-Mounted

Multi-Family Buildings

Industry 1st

Designed for Multi-family Buildings
in [Cold Climates](#)



100%

heating output down to $-4^{\circ}\text{F}(-20^{\circ}\text{C})$
with COP up to 2.0

-22°F

Continuous operation
as low as $-22^{\circ}\text{F}(-30^{\circ}\text{C})$



Enjoy Tax Credits & Rebate Savings with Extreme Heat Pumps



SEER2 up to **17.5**

EER2 up to **11.7**

HSPF2 up to **10.5**



ENERGY STAR® Cold Climate certified & **NEEP** certified

Meeting **CEE's Highest Tier**, eligible for up to **\$2000** 25C tax credits

U.S. Up to **\$2000**

CA Up to **\$5,000**

Eligible for the Canada Greener Homes Grant Program with a reimbursement of up to **\$5,000** for retrofit

Easy Upgrades No Matter the Climate Conditions

ENERGY STAR® Certified Heating Solutions Cover All Climate Conditions

Mild

ECO-AIR Inverter Heat Pump



Cool

ECO-AIR Inverter Heat Pump
+
Auxiliary Heater
(Up to 10kW)

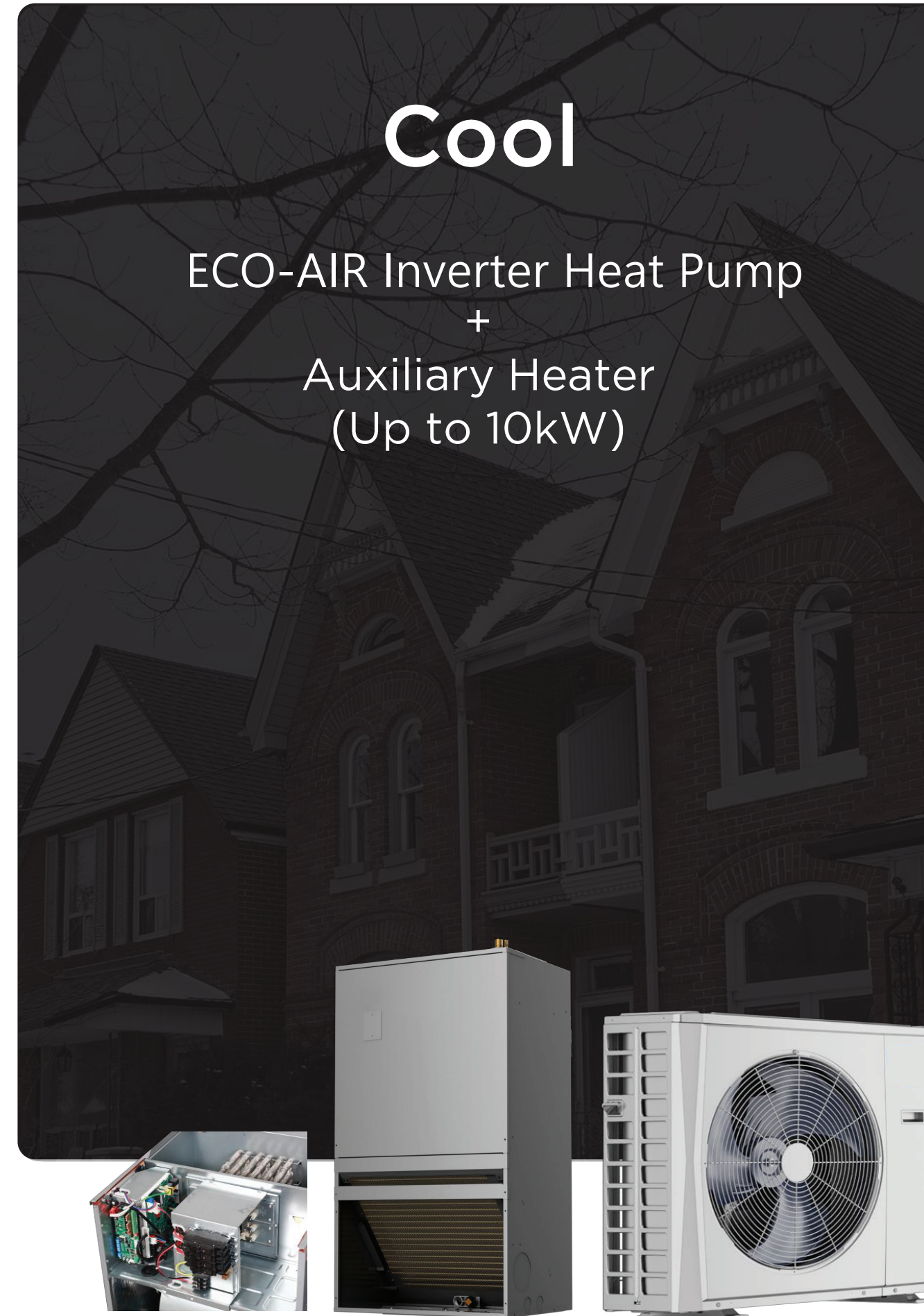

Cold

ECO-AIR Extreme Heat Pump
100% Heating Output at -4°F (-22°C)



Exclusive **BI-COMM** Technology, Compatible with 485 or 24V

Automatically identifying the control mode, no need for manual conversion

Communication mode

EVOX inverter heat pump unit is able to precisely receive and process signals from the communicating air handler to manage the air temperature and airflow inside a home and maintain them at the most comfortable levels.



Self-adapt mode

EVOX inverter heat pump has the ability to analyze the temperature and pressure change of the unit to adjust system operation. When matching it to non

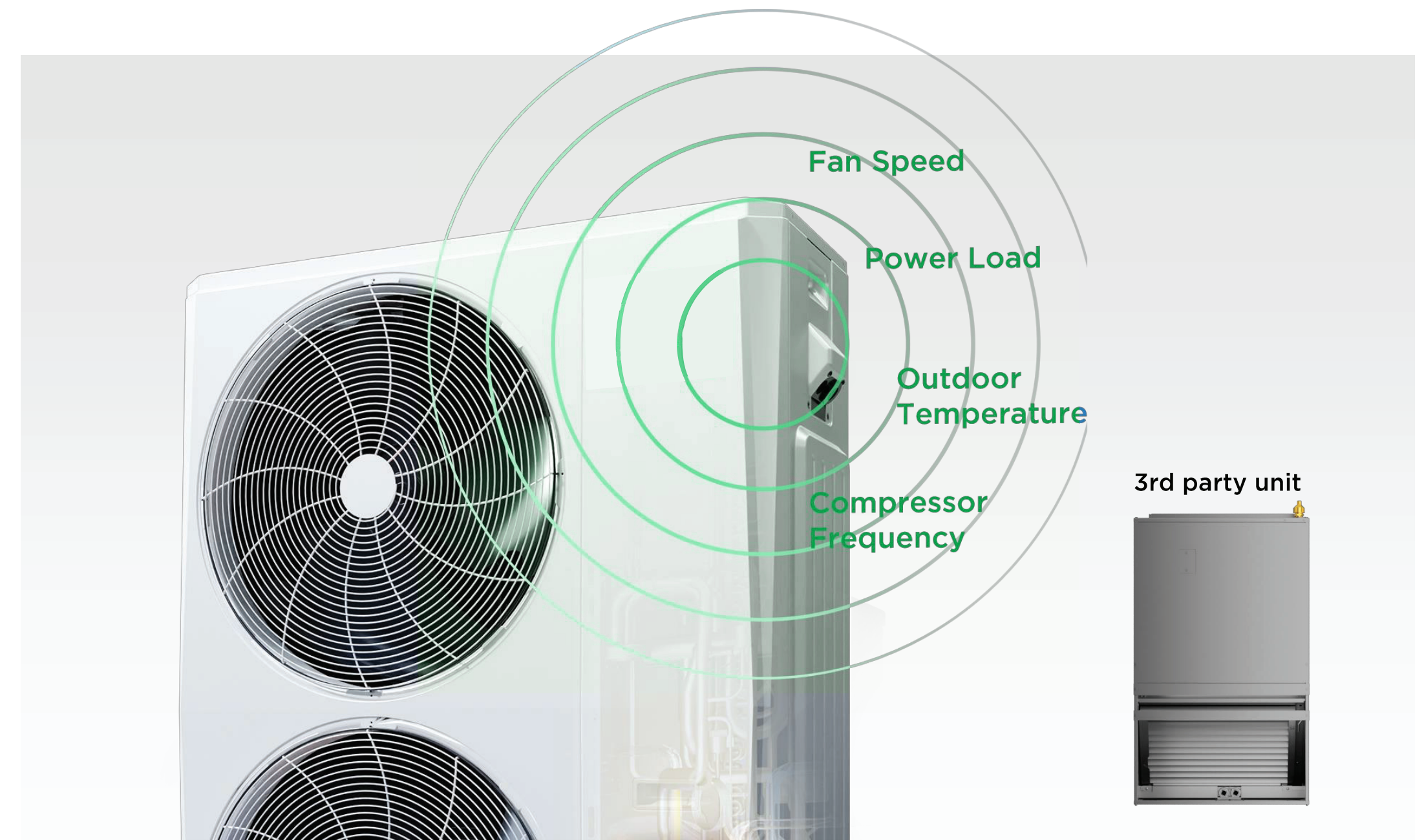

Flexible Mix & Match

No matter the pre-existing set-up, the EVOX system can flexibly mix and match with most third-party indoor units, outdoor units, and thermostats, even without changing wiring or refrigerant lines.



ECO-AIR Inverter Heat Pump
+
ECO-AIR Air Handler
+
ECO-AIR Wired Controller

ECO-AIR Inverter Heat Pump
+
ECO-AIR Air Handler
+
Third-Party 24V Thermostat

ECO-AIR Inverter Heat Pump
+
Third-Party Air Handler
+
Third-Party 24V Thermostat

Third-Party' Heat Pump
+
ECO-AIR Air Handler
+
Third-Party 24V Thermostat

Flexible Mix & Match

No matter the pre-existing set-up, the EVOX system can flexibly mix and match with most third-party indoor units, outdoor units, and thermostats, even without changing wiring or refrigerant lines.

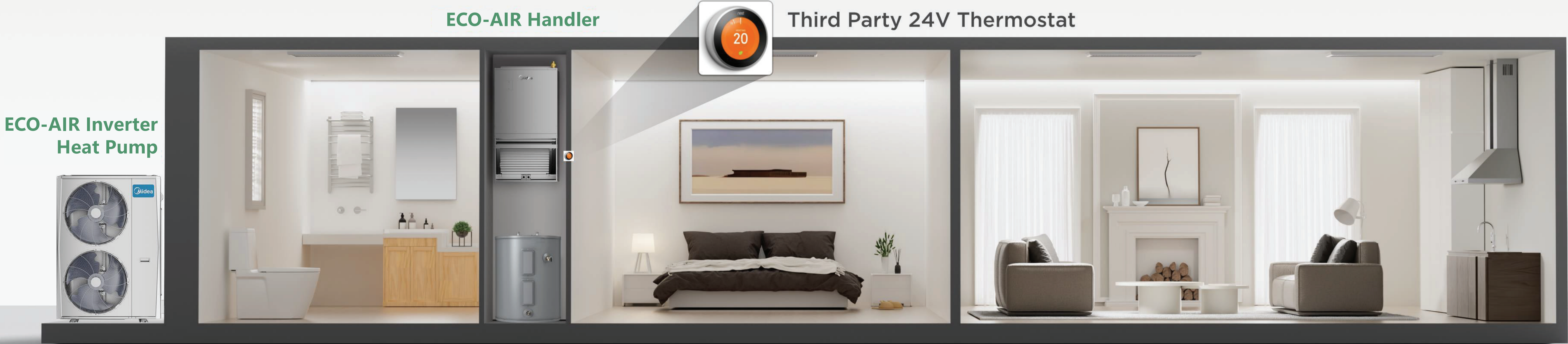

ECO-AIR Inverter Heat Pump
+
ECO-AIR Air Handler
+
ECO-AIR Wired Controller

ECO-AIR Inverter Heat Pump
+
ECO-AIR Air Handler
+
Third-Party 24V Thermostat

ECO-AIR Inverter Heat Pump
+
Third-Party Air Handler
+
Third-Party 24V Thermostat

Third-Party' Heat Pump
+
ECO-AIR Air Handler
+
Third-Party 24V Thermostat

Flexible Mix & Match

No matter the pre-existing set-up, the EVOX system can flexibly mix and match with most third-party indoor units, outdoor units, and thermostats, even without changing wiring or refrigerant lines.



ECO-AIR Inverter Heat Pump
+
ECO-AIR Air Handler
+
ECO-AIR Wired Controller

ECO-AIR Inverter Heat Pump
+
EVOX Air Handler
+
Third-Party 24V Thermostat

ECO-AIR Inverter Heat Pump
+
Third-Party Air Handler
+
Third-Party 24V Thermostat

Third-Party' Heat Pump
+
ECO-AIR Air Handler
+
Third-Party 24V Thermostat

Flexible Mix & Match

No matter the pre-existing set-up, the EVOX system can flexibly mix and match with most third-party indoor units, outdoor units, and thermostats, even without changing wiring or refrigerant lines.



ECO-AIR Inverter Heat Pump
+
ECO-AIR Air Handler
+
ECO-AIR Wired Controller

ECO-AIR Inverter Heat Pump
+
EVOX Air Handler
+
Third-Party 24V Thermostat

ECO-AIR Inverter Heat Pump
+
Third-Party Air Handler
+
Third-Party 24V Thermostat

Third-Party Heat Pump
+
ECO-AIR Air Handler
+
Third-Party 24V Thermostat

Wall-Mounted AHU

Easy Upgrade Solutions

Core Parameters

Up to 0.8" Static Pressure, one of the highest in the Industry

Extreme Heat



Model	Cool Capacity	EER2	SEER2	Heat Capacity	HSPF2-IV	5F Heat	5F COP	CVP
18K	18000	/	/	/	/	/	/	/
24K	24000	11.7	17.5	26000	10.5	24500	2.0	94.23
30K	30000	/	/	/	/	/	/	/
36K	36000	10	17.5	38000	9	33000	1.8	86.84

Core Parameters

Up to 0.8" Static Pressure, one of the highest in the Industry



Model	Speed	Air Flow Rate (CFM)				
		High Static Pressure (in.w.c.)				
		0"	0.2"	0.3"	0.5"	0.8"
18K	Turbo	621	621	621	621	621
	High	580	580	580	580	580
	Med-High	533	533	533	533	533
	Low	491	491	491	491	491
24K	Turbo	828	828	828	828	828
	High	763	763	763	763	763
	Med-Low	698	698	698	698	698
	Low	633	633	633	633	633
30K	Turbo	1095	1095	1095	1095	1095
	High	899	899	899	899	899
	Med-Low	811	811	811	811	811
	Low	716	716	716	716	716
36K	Turbo	1195	1195	1195	1195	1195
	High	1089	1089	1089	1089	1089
	Med-Low	976	976	976	976	976
	Low	870	870	870	870	870

Compact-Size Wall-Mounted AHU Smoothly Fits Into Any Existing Installation Space

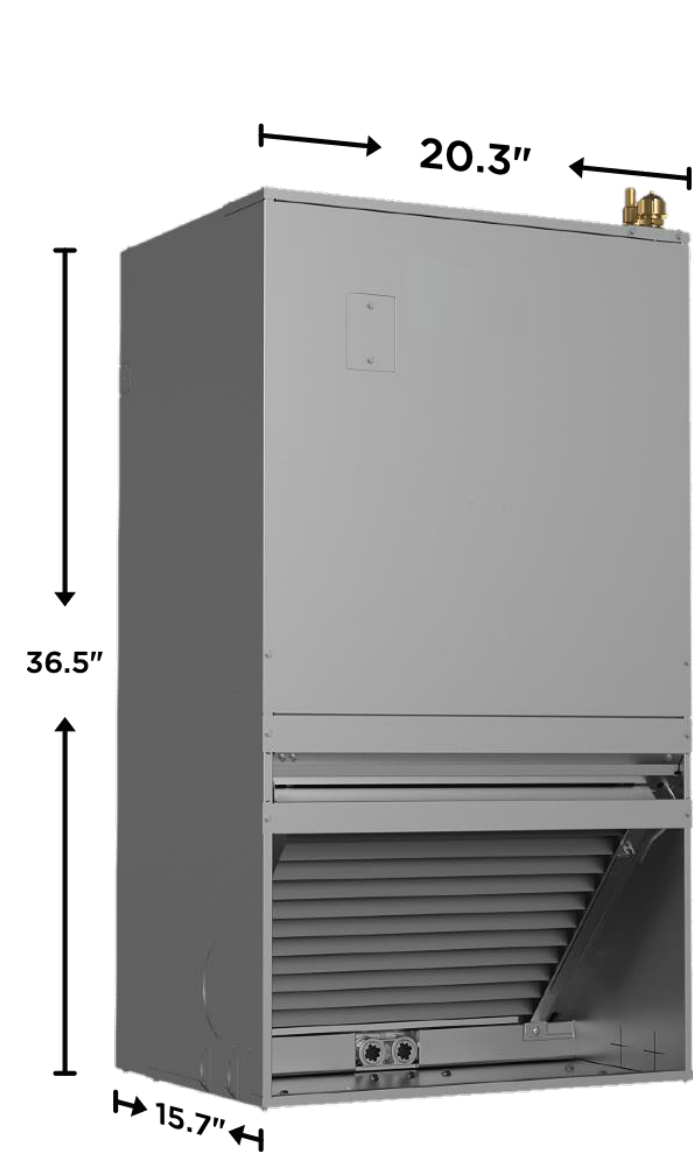

18k-24k Model



30k-36k Model



Easier Replacement with more space for installation operation

Adpt

Adpt

Easy to Adpt

Adpt

Adpt

Most air handlers on the market are intolerant to varying static pressure conditions

Their initial setting is designed for the best performance only under certain static pressures

But **Static Pressure** varies in different conditions

Ductwork Design



Filter Condition



Kinks & Dirt in Ducts



Conventional Airflow Technology

The airflow decreases as the static pressure increases

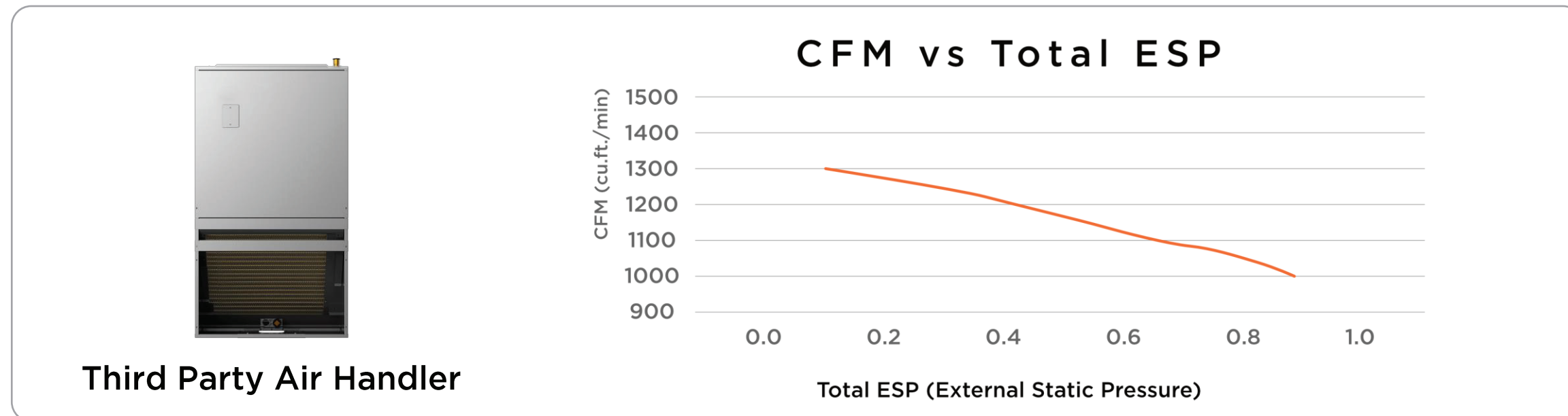

Third Party Air Handler

There is no adaptability to different ductwork designs in different homes

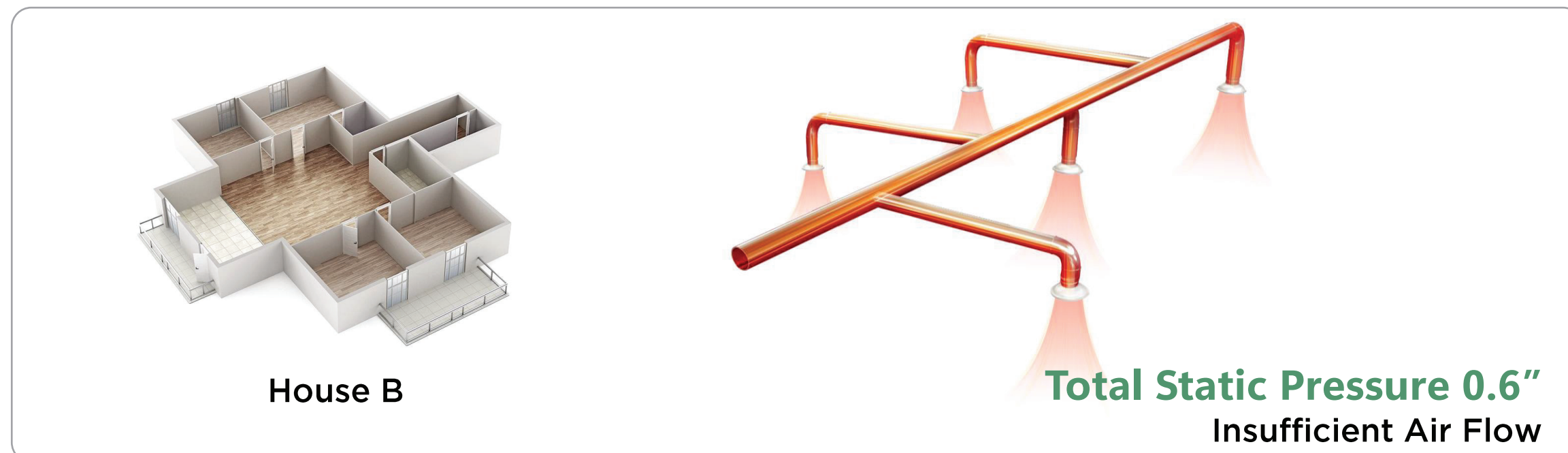
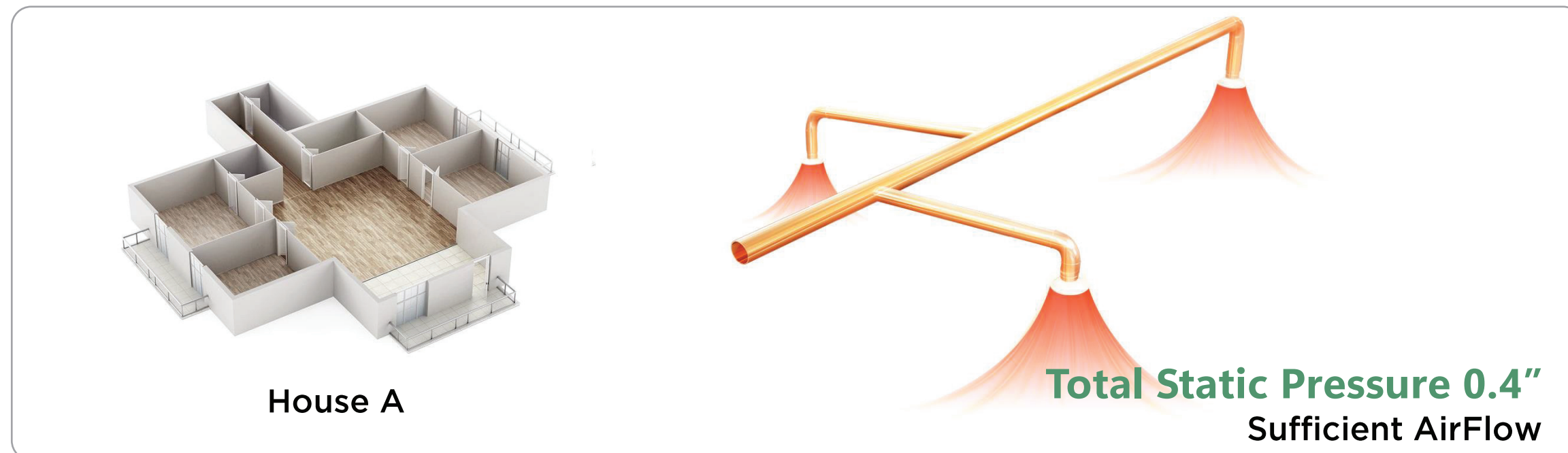

As a result



Up to 36%

More Installation and Setup Time

- Repetitive CFM measurements
- Complicated air balance adjustments



Computational Constant Airflow 2.0

Ensures Constant airflow within 0.8" Static Pressure

Computational Constant Airflow technology enables airflow to automatically adapt to the existing ductwork design, or issues caused by blocked coils, dirty filters and improper duct sizing. This is done by adjusting output power and fan speeds. Even with no call for heating or cooling, the Computational Constant Airflow technology will still work to ensure optimal airflow.

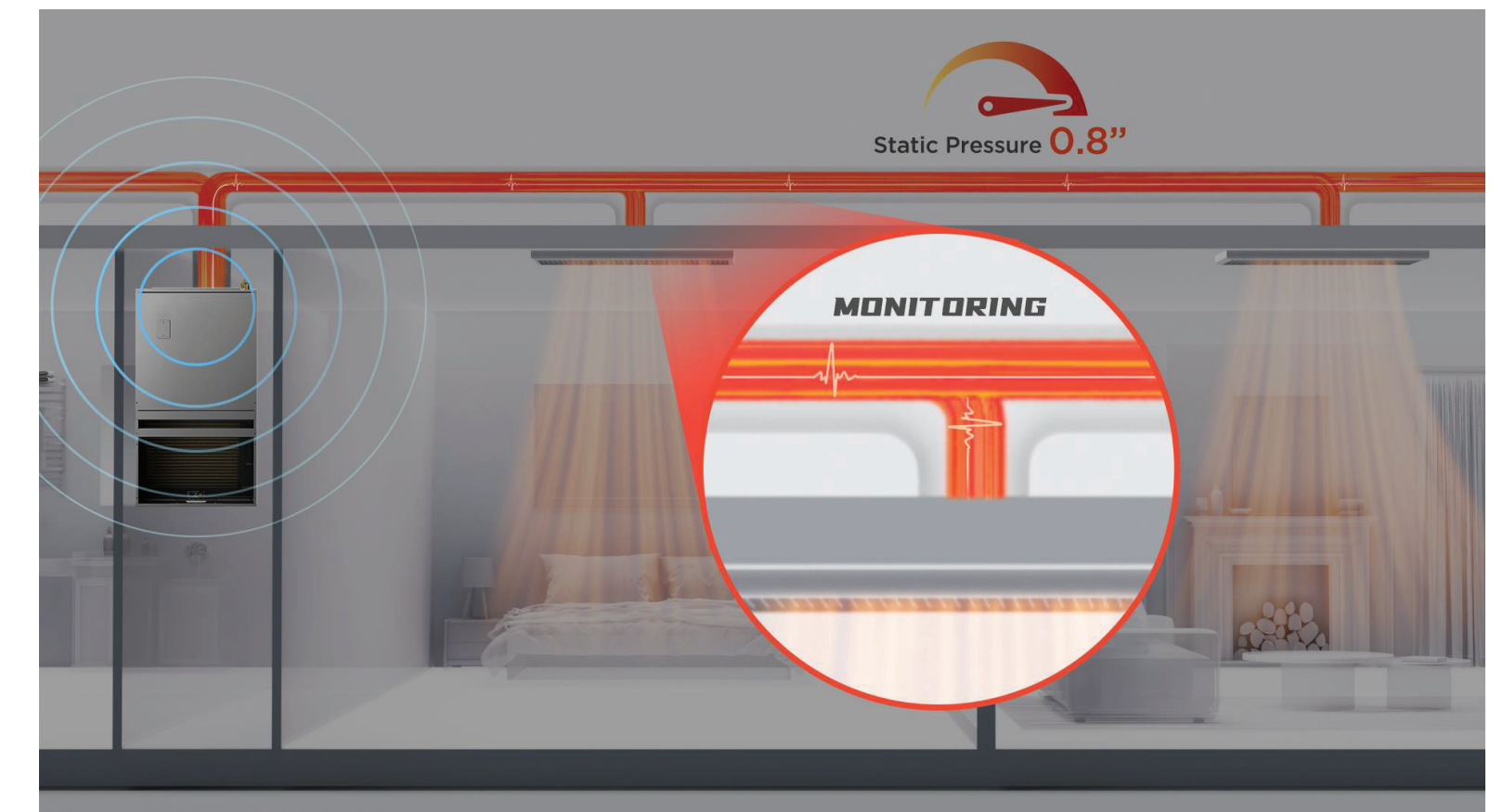
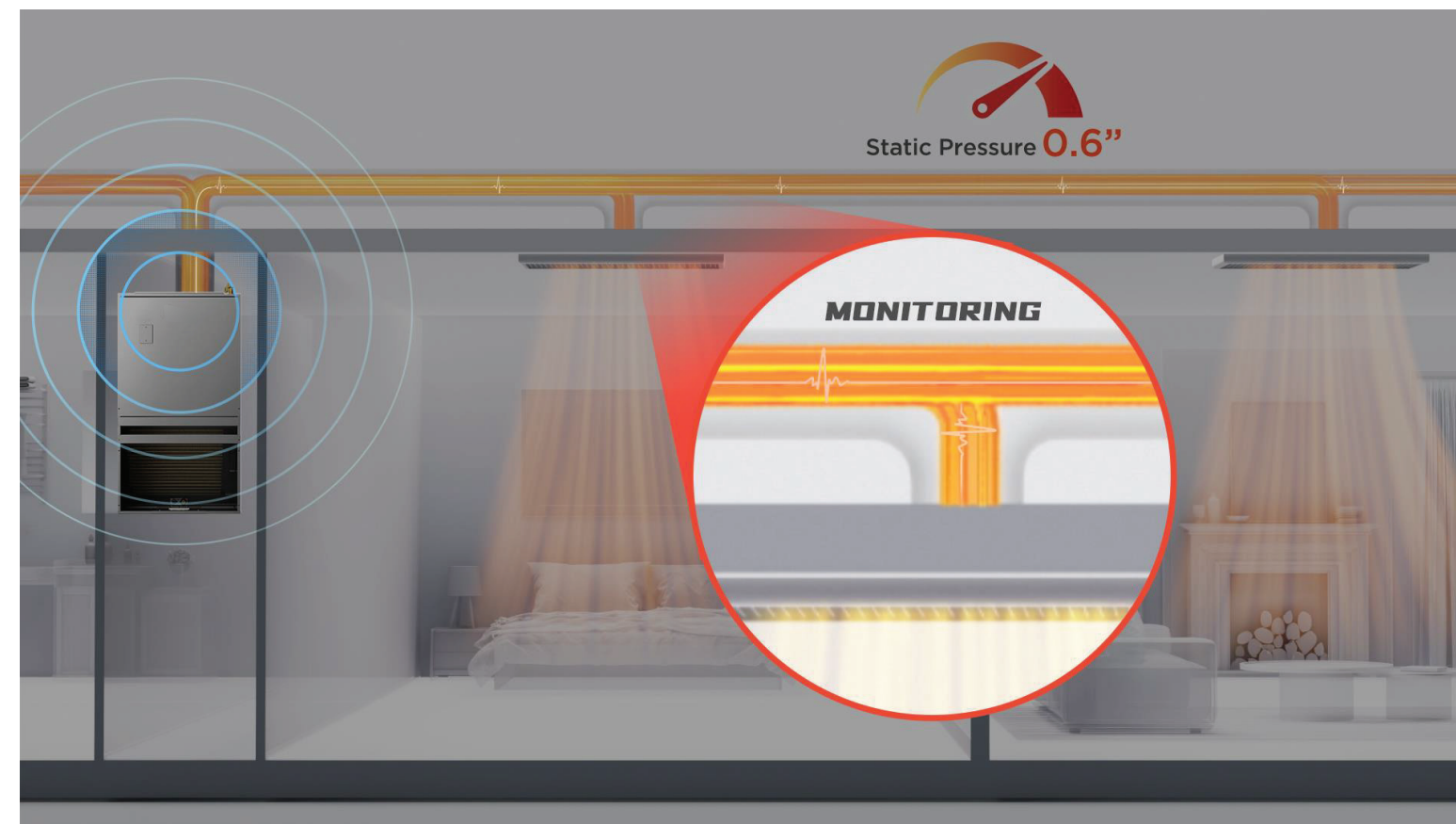
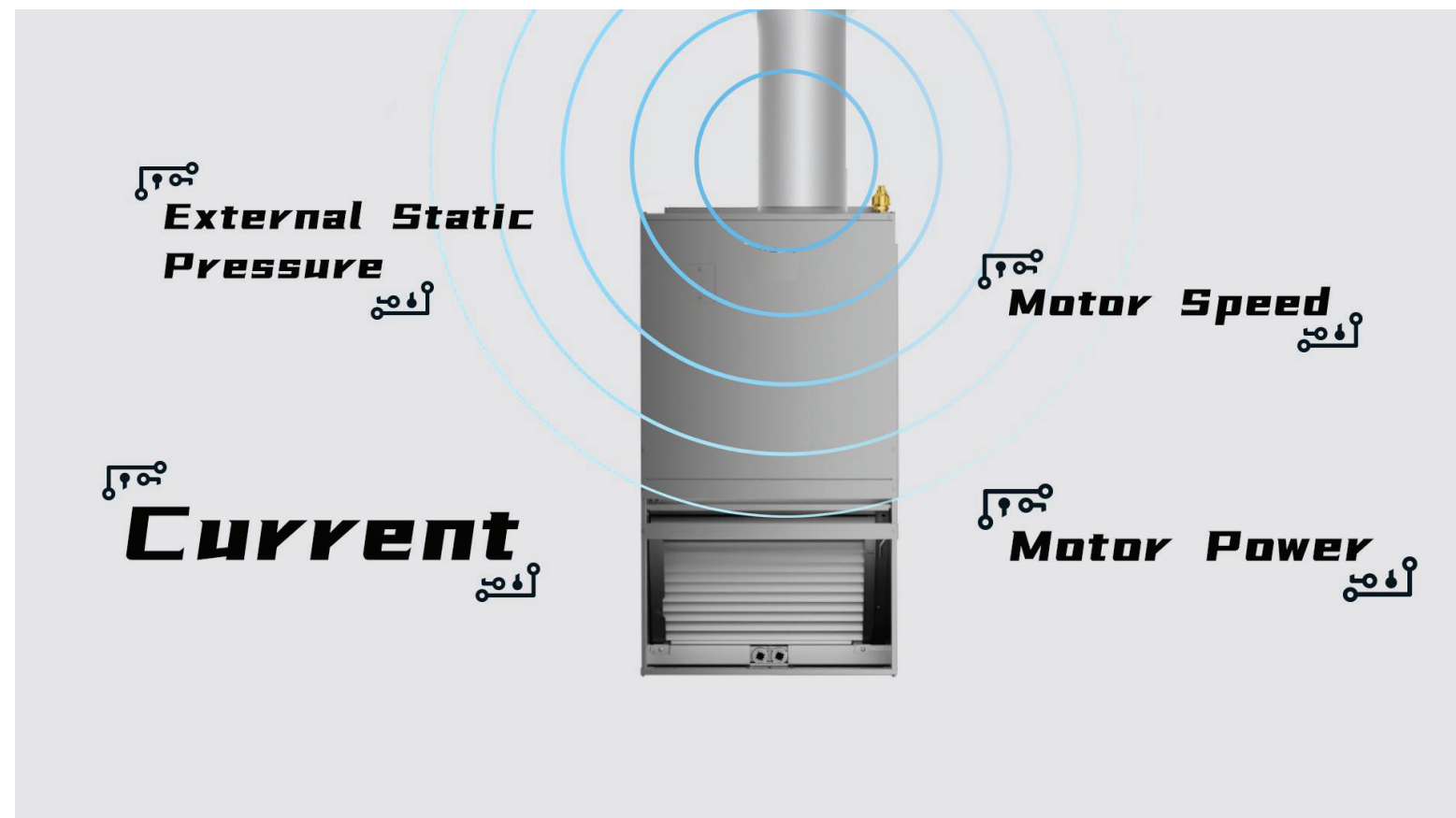

Easily Adapts to Different Ductwork Designs in Different Homes

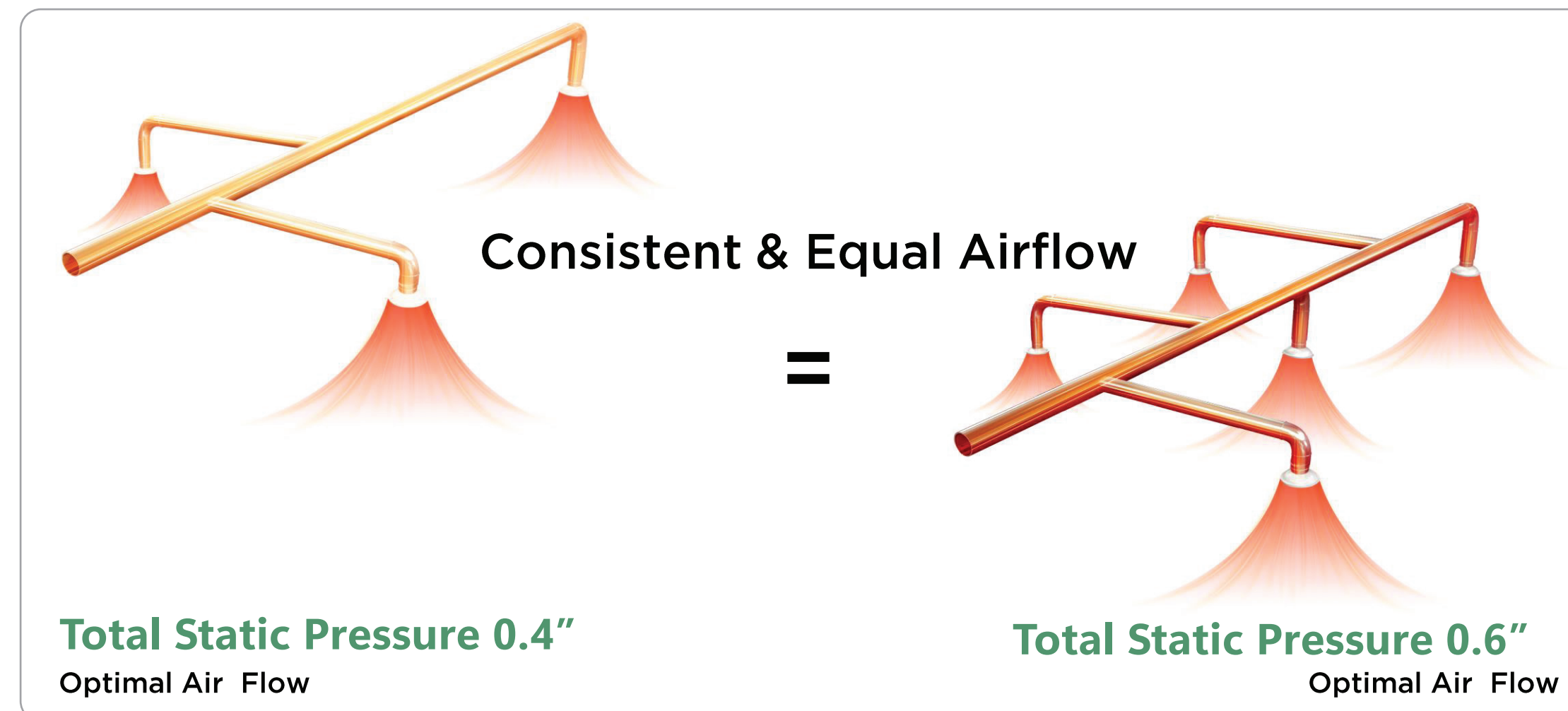
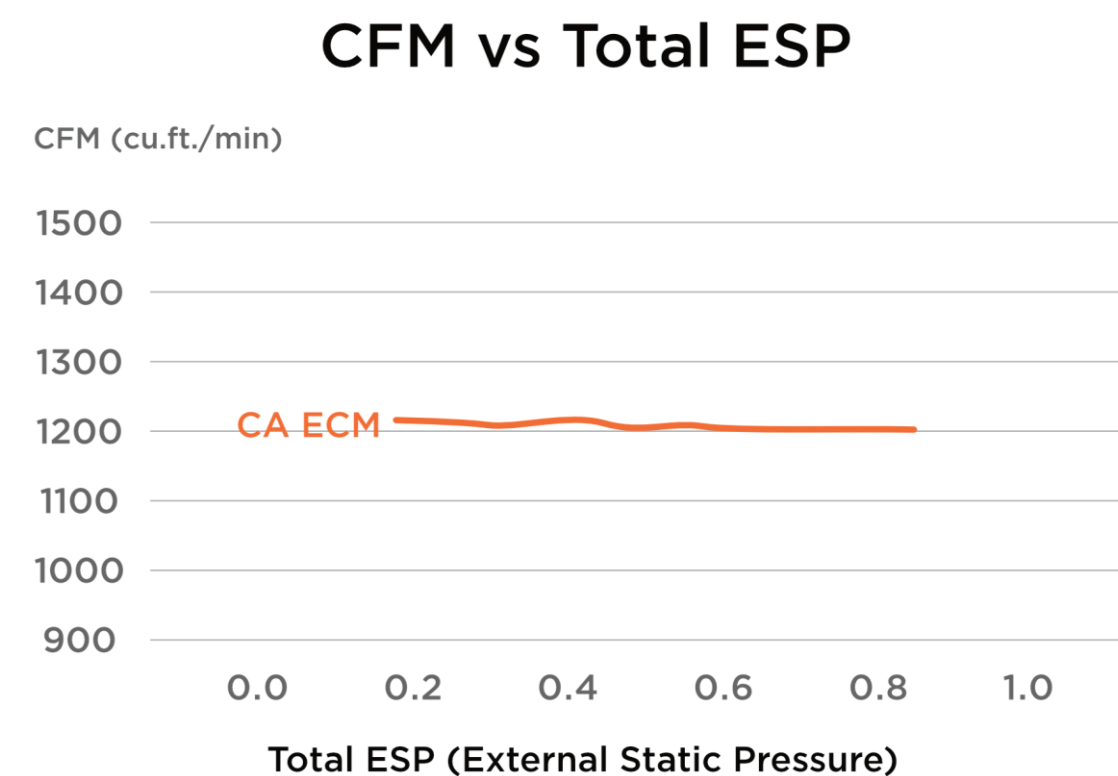

Constant Airflow through High Density Filter

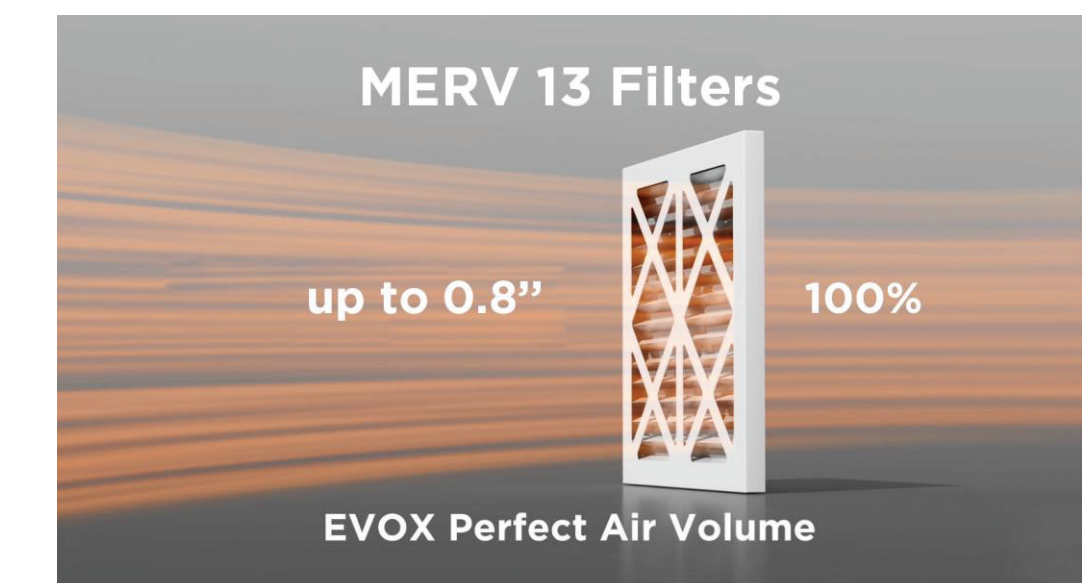

So it makes installation much easier



Computational Constant Airflow 2.0

Customized Air Volume for the whole home

The upgraded Computational Constant Airflow technology also offers flexibility to adjust whole-home air volume according to the customers' personal needs. All of the adjustments can be made easily through the "Engineer Mode" on the remote control/wired controller.



Up to 60 Level
air volume options

Need Milder Airflow



When customers feel uncomfortable about the current air volume.

To Reduce Air Volume

To Increase Air Volume

CFM vs Total ESP

CFM (cu.ft./min)

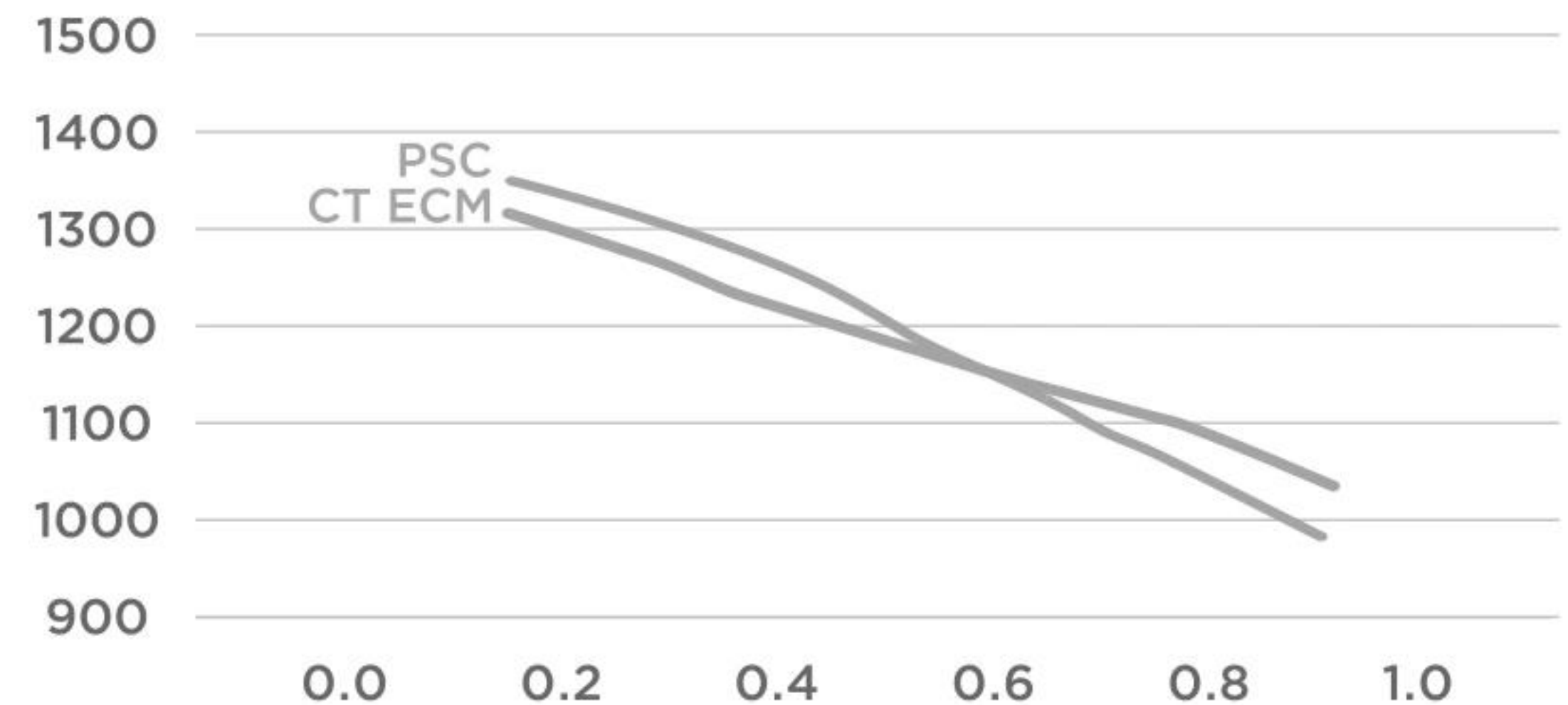

Total ESP (External Static Pressure)

- CA ECM: EVOX Wall-Mounted AHU
- CT ECM or PSC: Conventional AC

Computational Constant Airflow 2.0

Customized Air Volume for the whole home

The upgraded Computational Constant Airflow technology also offers flexibility to adjust whole-home air volume according to the customers' personal needs. All of the adjustments can be made easily through the "Engineer Mode" on the remote control/wired controller.



Up to 60 Level
air volume options

Need Stronger Airflow

When customers feel uncomfortable about the current air volume.

To Reduce Air Volume

To Increase Air Volume

CFM vs Total ESP

CFM (cu.ft./min)

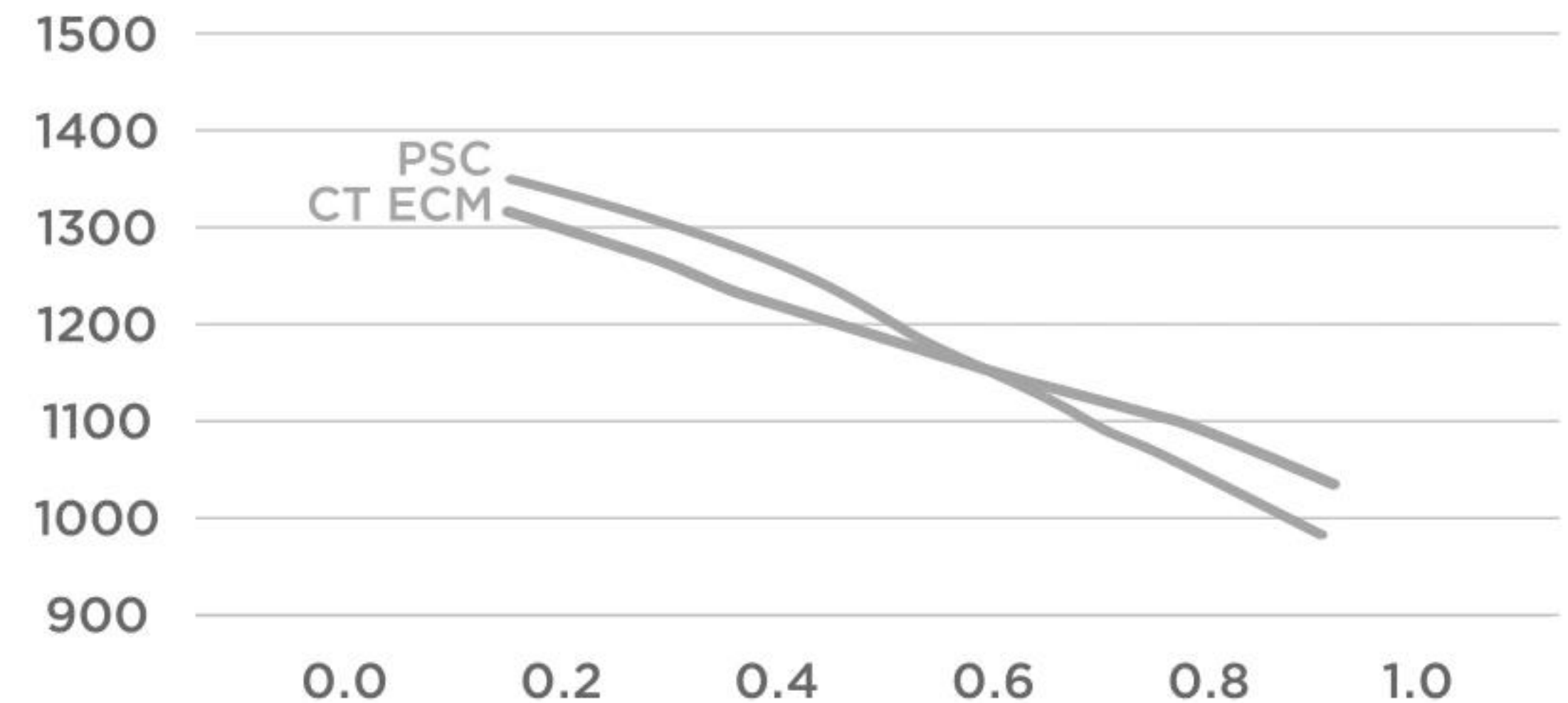

Total ESP (External Static Pressure)

- CA ECM: EVOX Wall-Mounted AHU
- CT ECM or PSC: Conventional AC

Enjoy

Enjoy

Enjoy

Easy to Enjoy

Enjoy

Enjoy

Enjoy

**Upgraded Comfort with
Better Inverter Technology**

Quieter Operation

Better Acoustic Comfort with Midea Side-Discharge Inverter Heat Pumps

Down to **54 dB(A)**



1.5 ton model



1.5 ton model

> 70 dB(A)

Quieter than traditional top-discharge heat pumps

Easier Control

Multiple control methods to maximize user convenience.

Wired Controller

Built-in WiFi



Mobile Phone

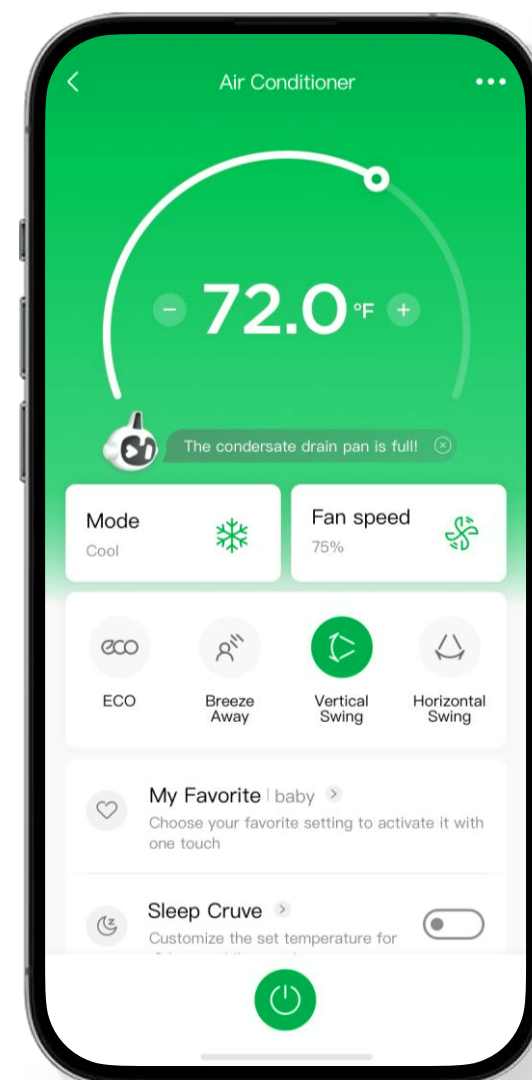

Voice

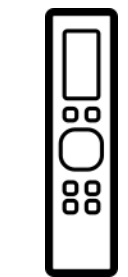

Remote Control

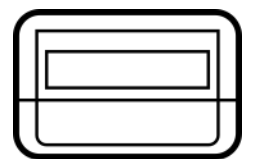

Central Control

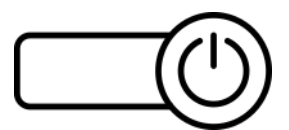

Remote On/Off



24V Thermostat Control

Smarter Control

Control the indoor climate anywhere & anytime for an ultimate comfort experience

Geolocation

Set your homes' location to automatically adjust comfort levels based on your proximity.

Sleep Curve



Perfect comfort upon arrival

Smarter Control

Control the indoor climate anywhere & anytime for an ultimate comfort experience

Geolocation

Sleep Curve

Customize the hourly temperature setting in advance or simply switch to the recommended temperature curve to enjoy a restful sleep.

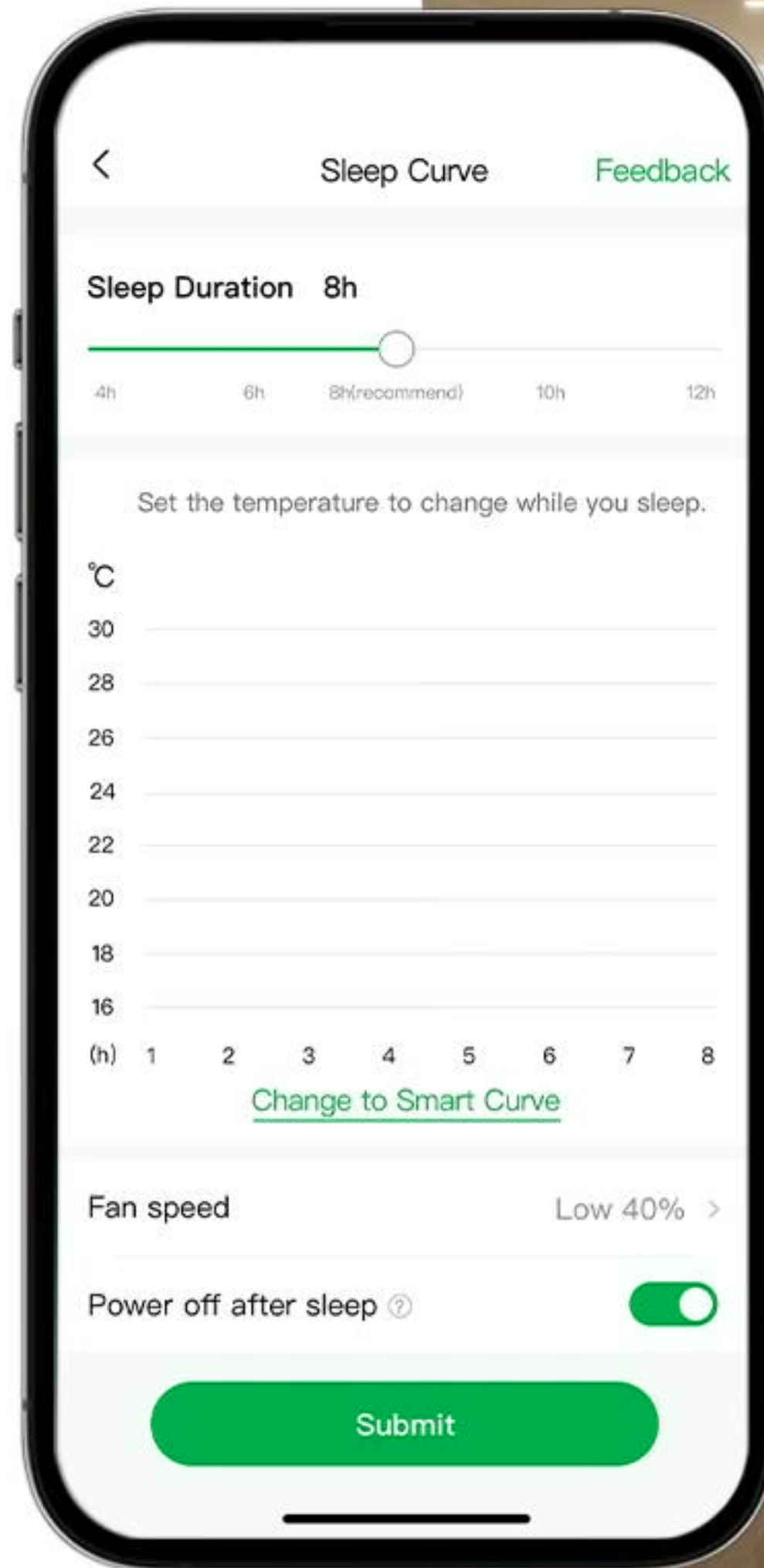

NO more waking up hot / cold during sleep

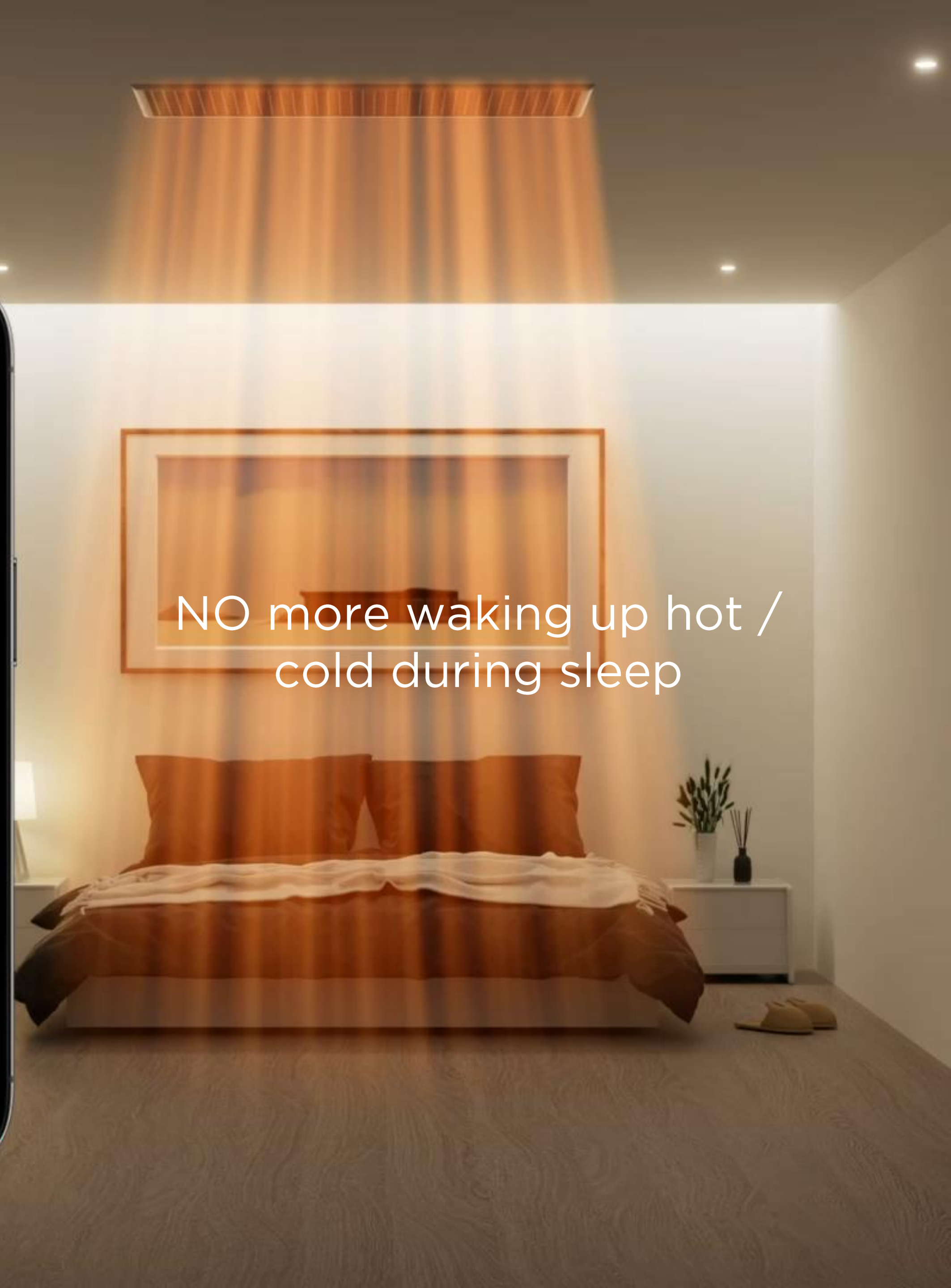

Service

Service

Service

Easy to Service

**Not Only Easy for Customers
But Also for Installers**

Service

Service

Service

Easy-to-Access Design

Just remove 2 screws for access to the error code display



Slide-Out Design

One action to push in or take out the filter



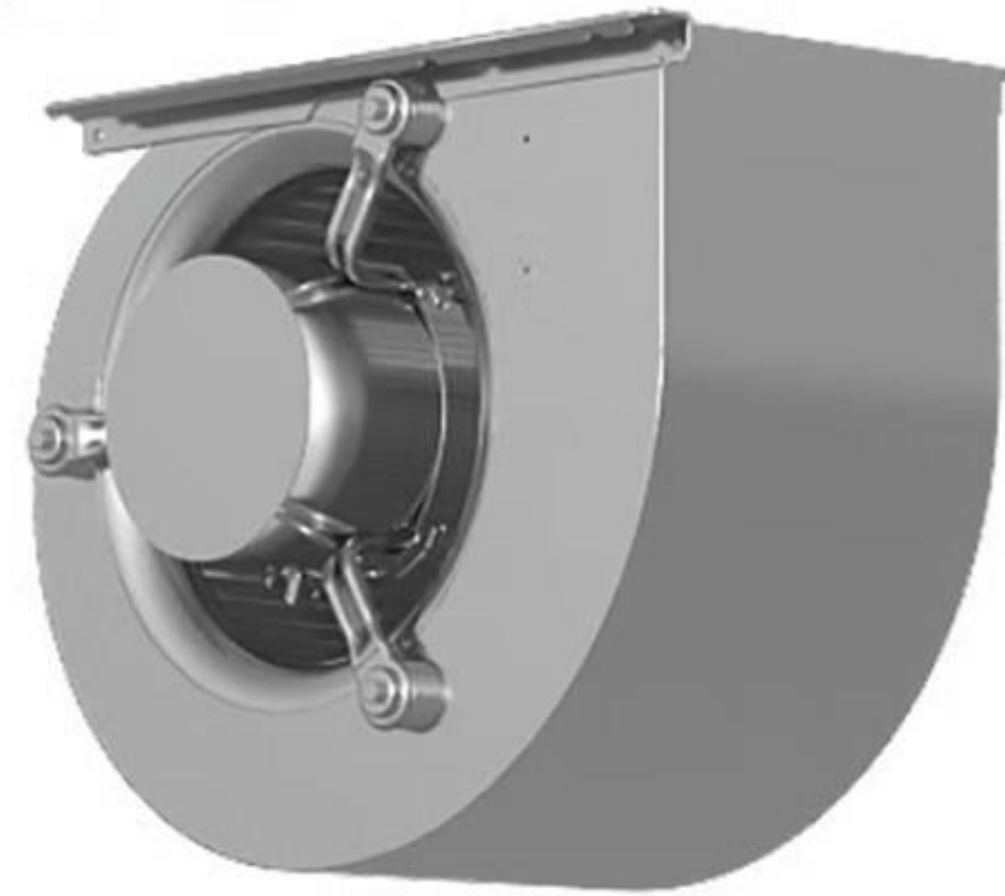
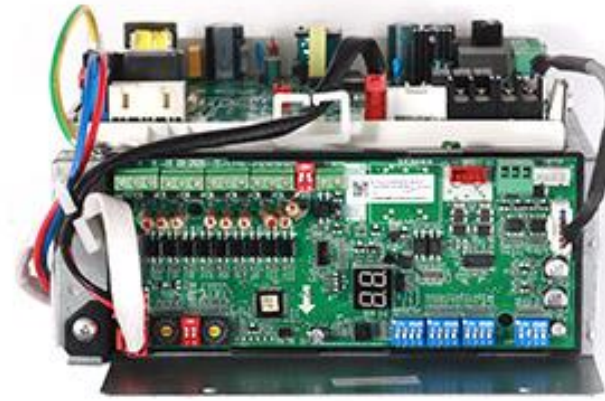

Easy-to-Maintain Design

- Control Box

The electric control box is fixed by only two screws and can be easily pulled out.

- Fan Motor

Disassemble the top cover, then easily take out the fan and motor assembly without the need to disassemble the evaporator.

Slide-Track Design

There are no side screws, so the evaporator coil can be easily pulled out through the slide track from the front side.

Aluminum Evaporator Coil



Full Front Access

No screws on the side



Easy HVAC Upgrade Solutions For Every Family

